

FSC-DB004 DISCOVERY LITE User Guide

Version: V1.2

Released Date : 2017.02.13

Shenzhen Feasycom Technology Co.,LTD

Contact: Onen Ouyang Email: onen.ouyang@feasycom.com

Contact: Rimly Rong Email: rimly.rong@feasycom.com

Address: Room 2004,20th Floor,Huichao Technology Building,Jinhai Road,
Xixiang ,Baoan District,Shenzhen,518100,China.

Tel: 86-755-27924639

FSC-DB004 DISCOVERY LITE Front Image

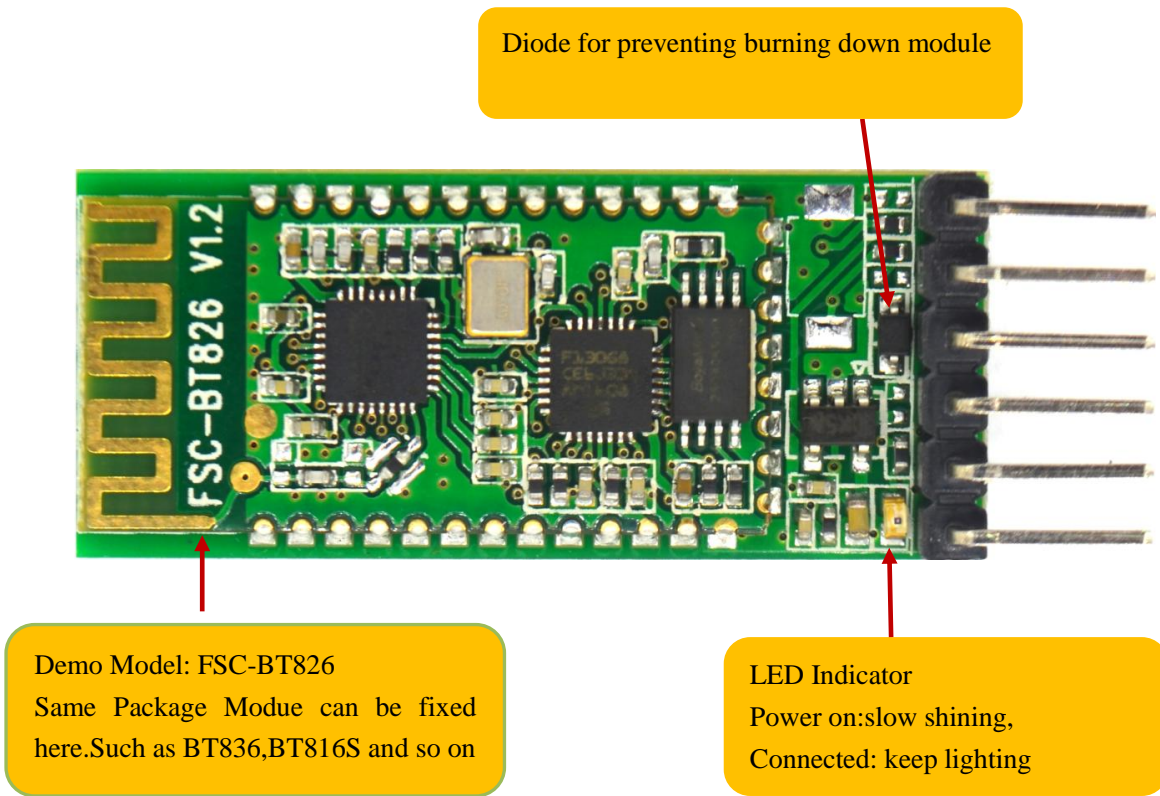

FSC-DB004 DISCOVERY LITE Back Image

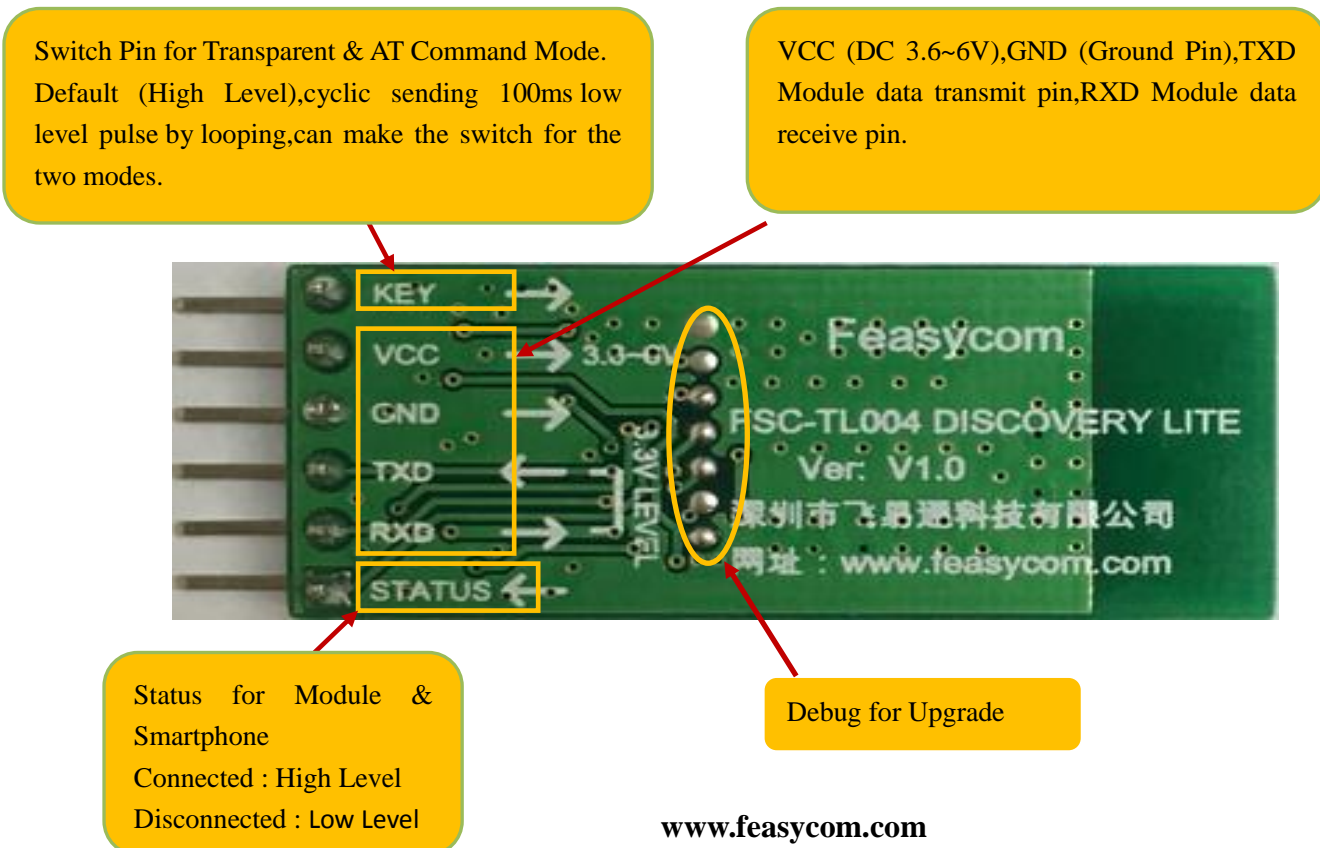

P1.Hardware Environment Establishment

1.Module & Upper Monitor Connecting Sketch ([Using Serial Board for Demo](#))

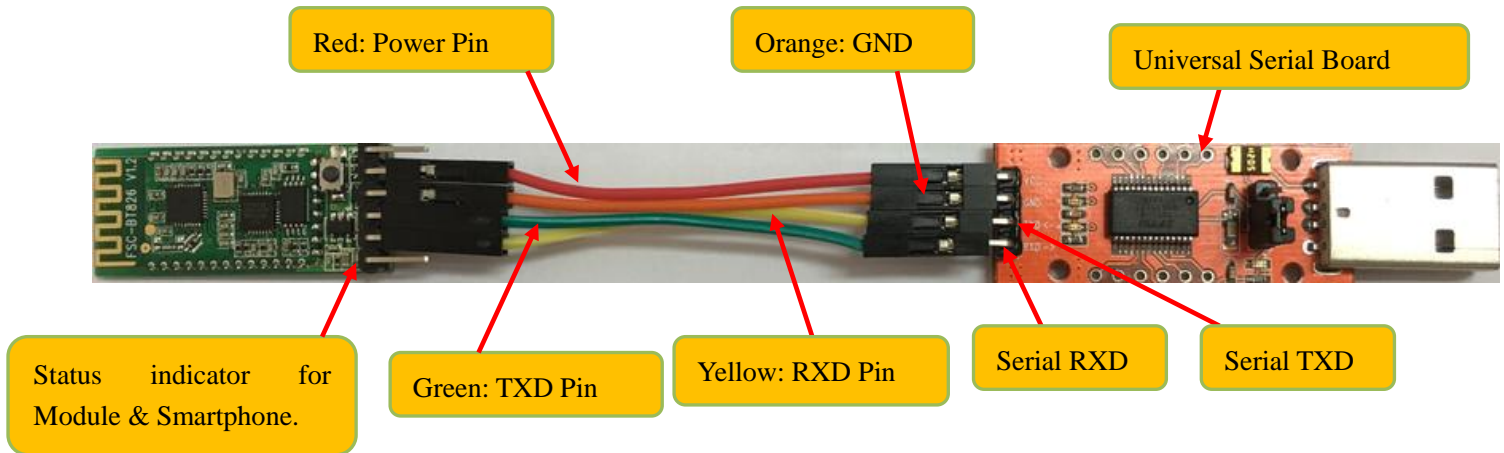

2. APP Download (Android & iOS)



1) Android APP **BTComm**, please download from our www.feasycom.com or contact the sales man.



2) iOS APP **BLE Assistant**, download from appstore or contact the sales man.

P2. Using steps:

1. Serial board connect to the PC's USB Port, the module under the searchable and connectable status, LED Indicator light is slow shining as the below picture showing.

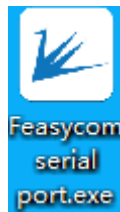

2. Open Feasycom serial port tool [port.exe](#), setting as below.

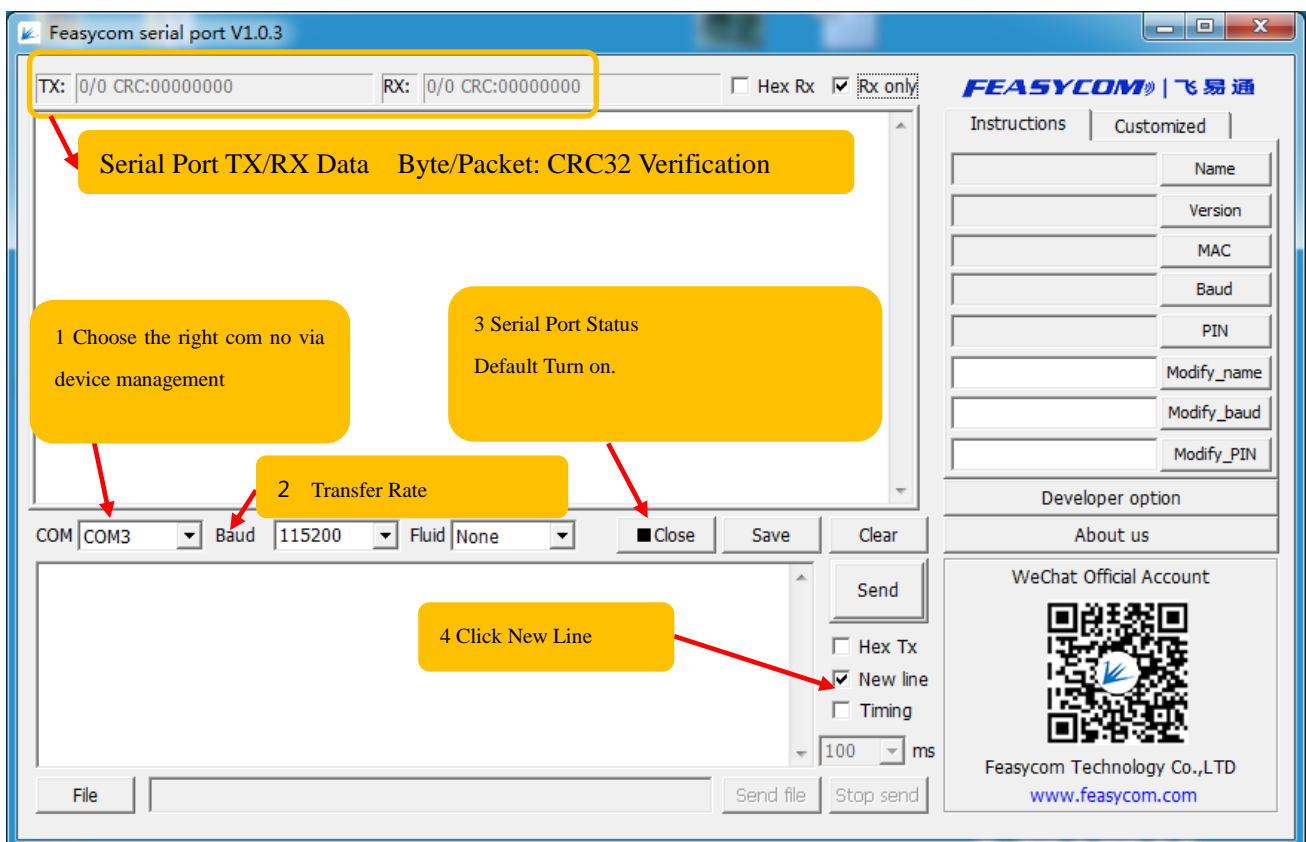

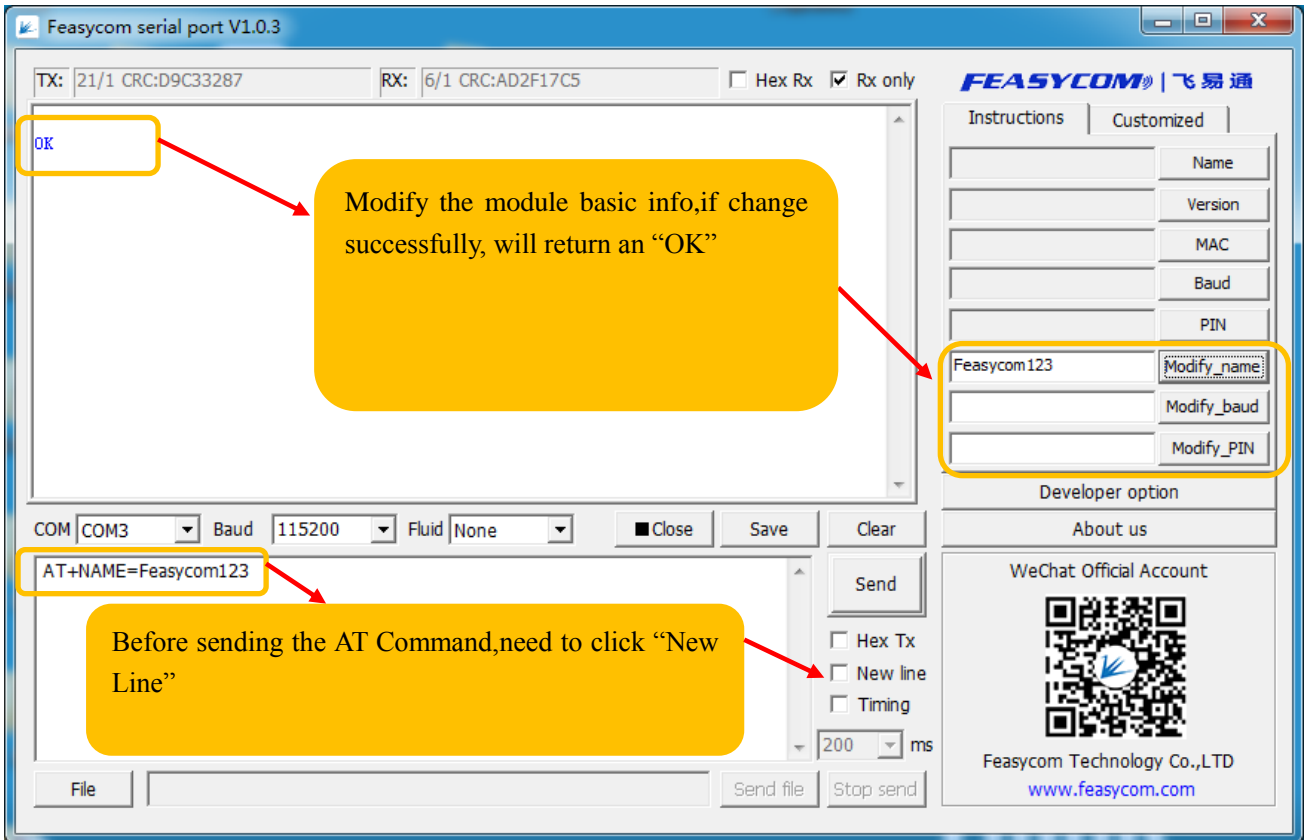
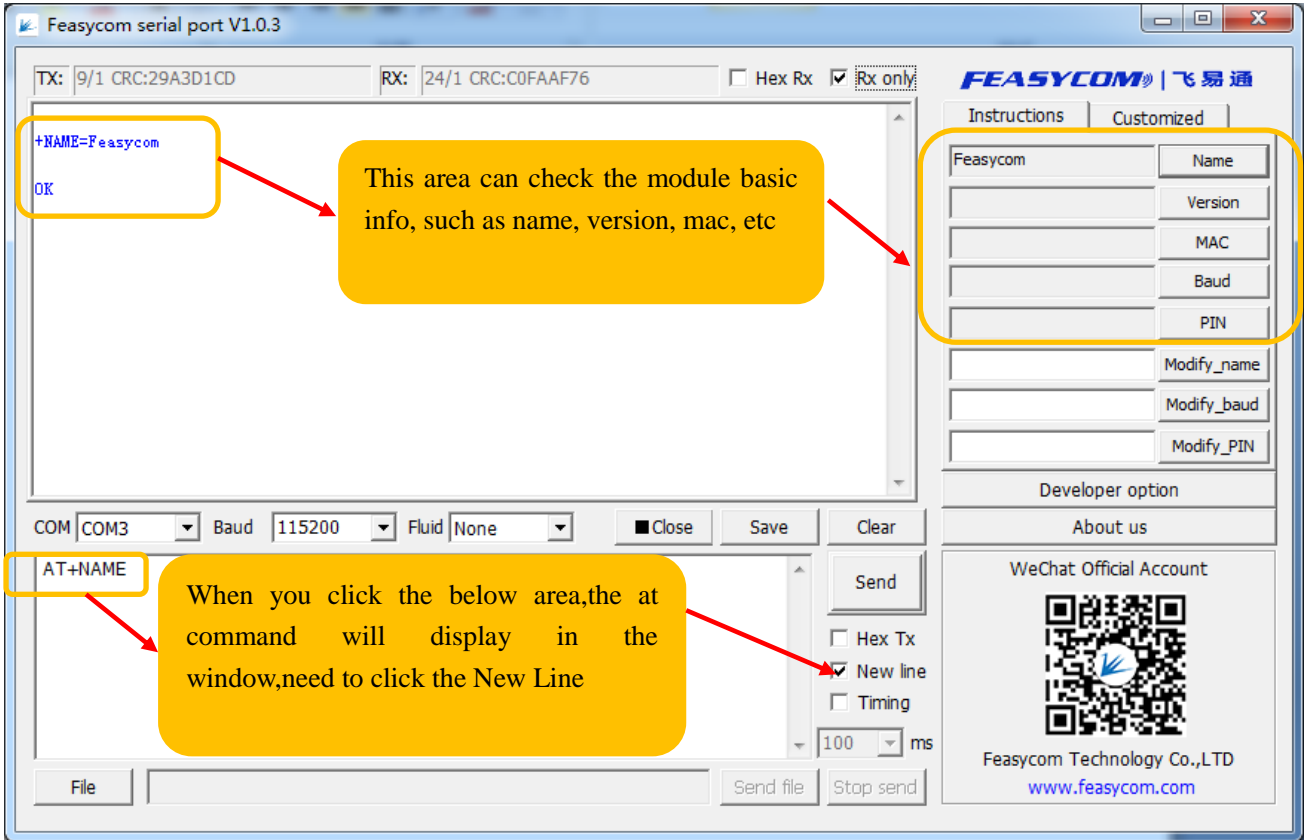

3 Smart Phone APP connect to the module, please follow the below steps (Turn on Bluetooth of Smart phone)

1>Android System : Open BTComm APP , search the target Bluetooth device,click auto-connect,glide the interface can get the newest searching devices.

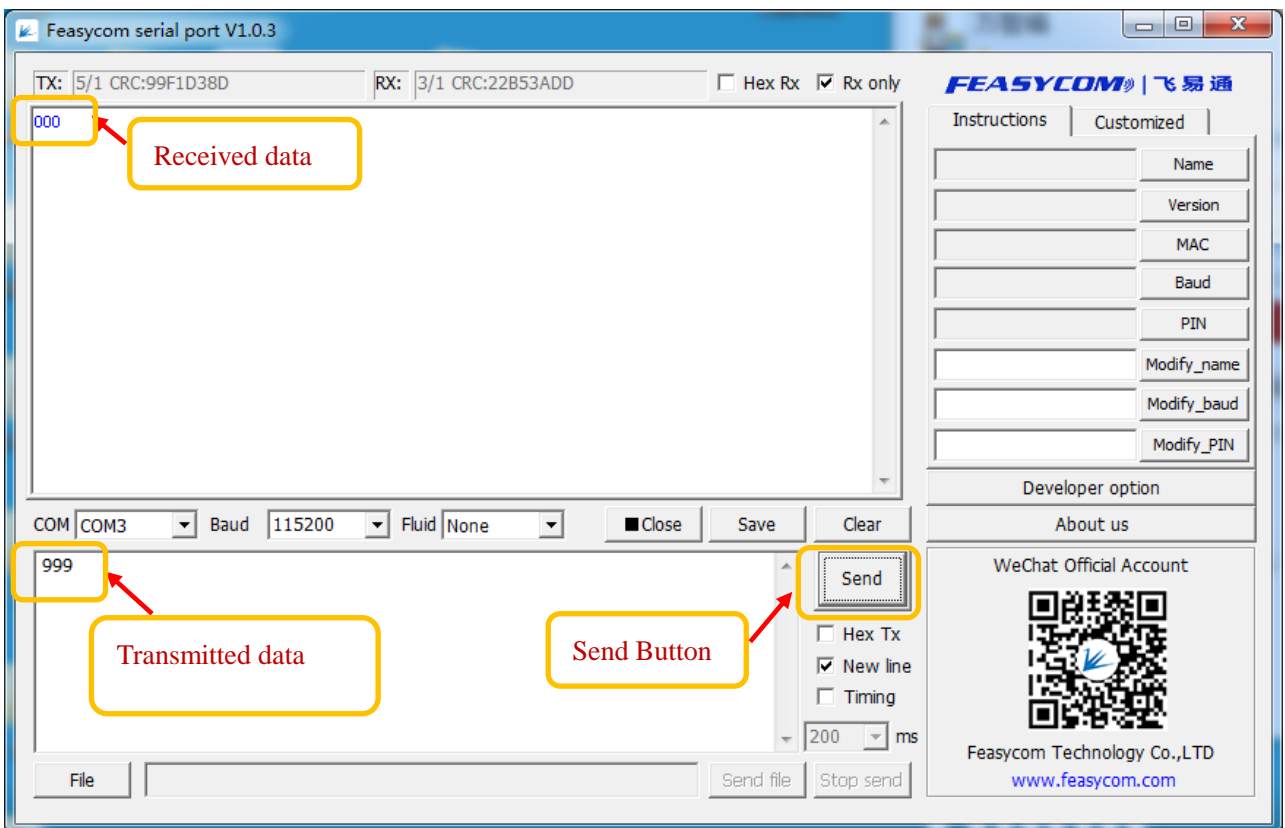
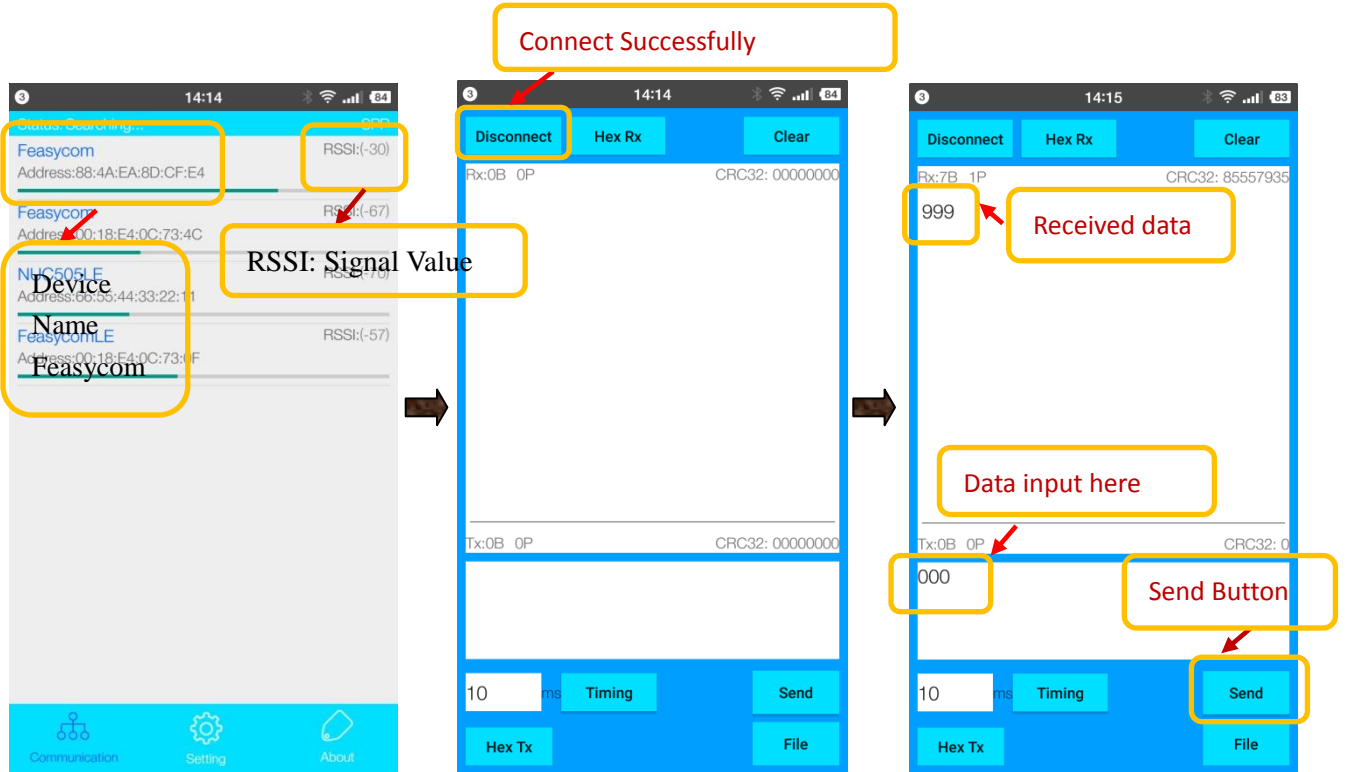

2> IOS System : Open BLE Assistant APP, search the target Bluetooth device,click auto-connect, glide the interface can get the newest searching devices.

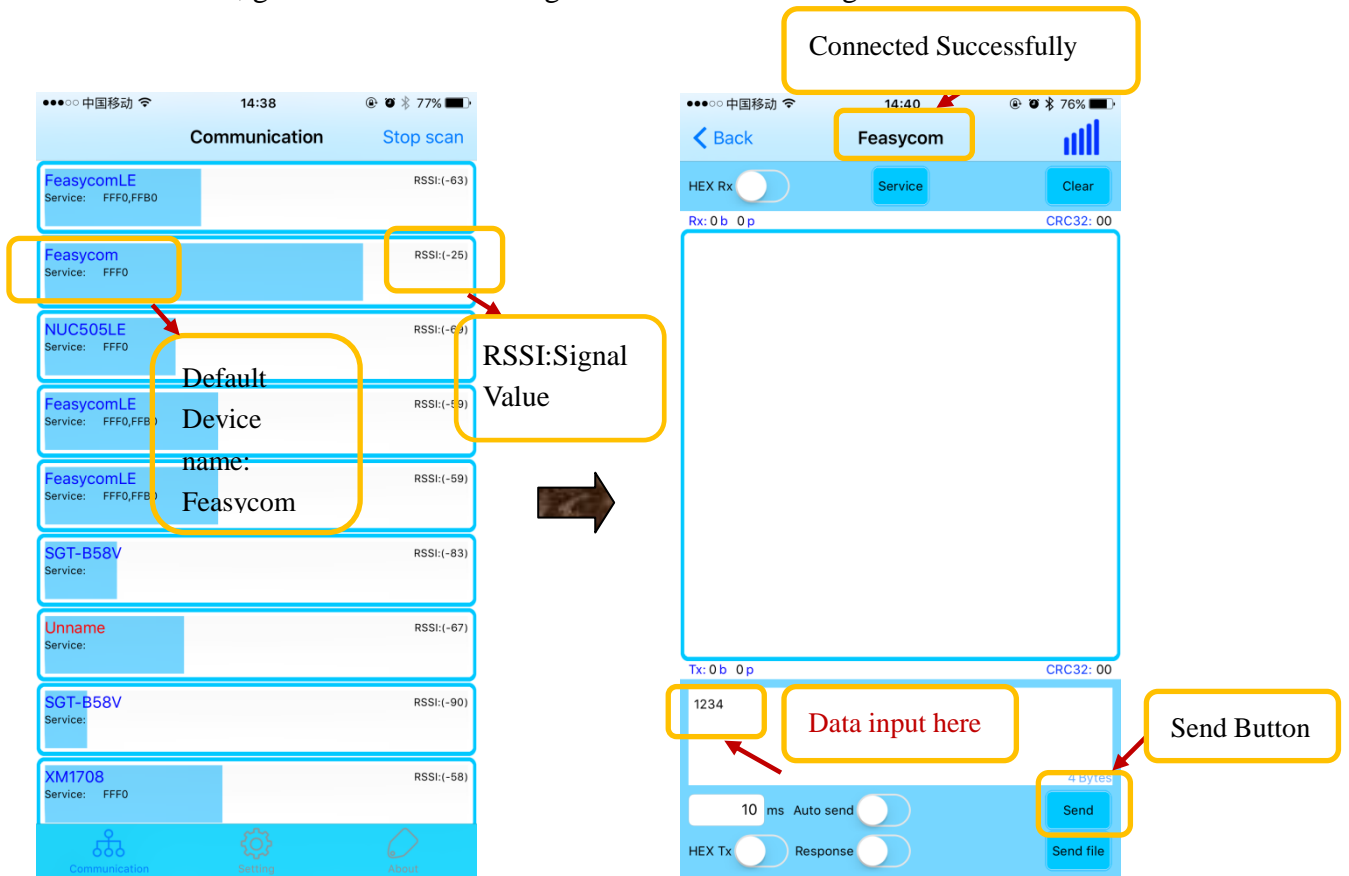

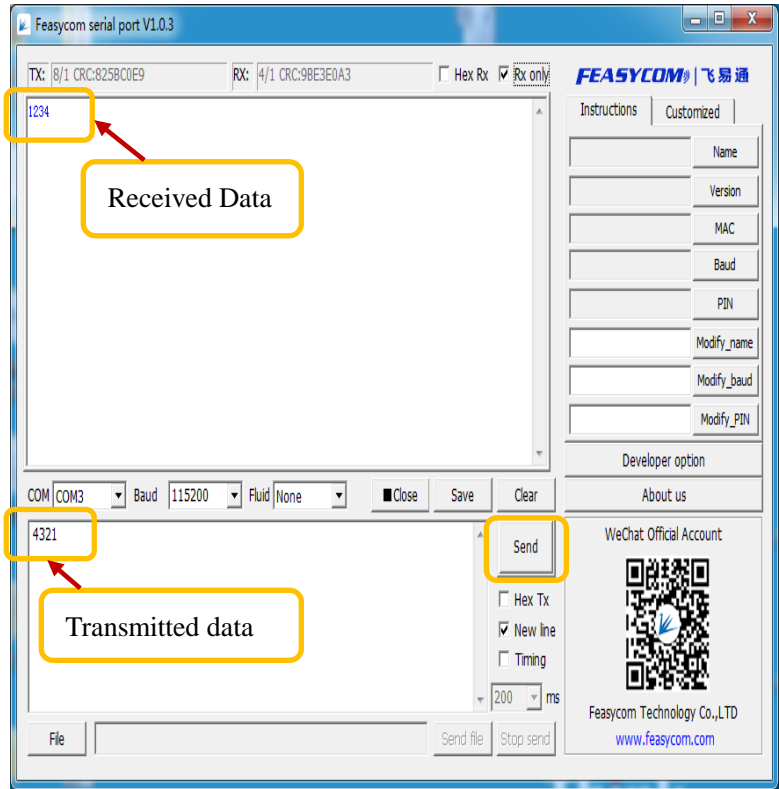
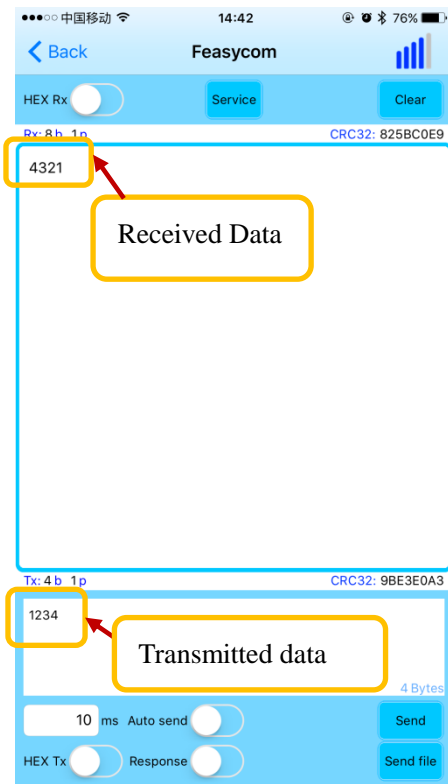

P3 FAQ

Q1 : Power On Module, RX Command ,no feedback :

1. Check the indicator Light : Flash or not
2. Make sure the COM NO : Correct or not

a)  Baud Rate Parameter:115200

b)  Serial Port Close or Open

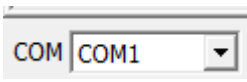
c)  COM NO, whether is same as the device management of computer displaying

d) RXD Pin connect to Module TXD Pin,TXD Pin connect to Module RXD Pin.

e) ,whether click this button.

Q2 Check the module whether under connection status

Remarks: If the module already connected to the smart phone, the module received AT command information will be sent to the smart phone as the common data information, will not execute the AT Command.

Q3 If already follow the steps as above showing , still can not identify the AT Command, better to make the module connect the smart phone APP, using the APP to send "12345" to the module, using the OSC to monitor the TXD of the module, whether there coming out the wave shape. Send the data to the module, using the OSC to monitor the RXD of the module, whether there coming out the wave shape, meanwhile, check the smartphone get the data or not.

Q4 Android Smart Phone why can not use the BLE:

1. Some old android smart phone not support BLE (We suggest to use our Bluetooth dual mode module)